

Overview

Thank you for purchasing this portable digital video camera, Various camera modes built -in, up to 64 million camera pixels and 4K video resolution , it adopted Sony 1/2.8-inch image sensor, the video file storage usage is small while it has high image quality! You can connect your camera via Wi-Fi using your smart Phone remotely, to view the camera live screen and use your phone to record or shooting.

Safety Instructions

- Do not drop, impact or puncture the camera.
- Do not expose the camera to high/low temperature, excessive dust, humidity or strong vibration, otherwise the product may be damaged.
- Do not use corrosive chemicals or solvents to clean the product.
- Do not disassemble this camera or attempt to repair or modify it in any manner, if there is any damage to the camera, stop using the camera and return this product to the store where you have purchased it from, the product will be sent back to the company and fix.

Cautions

- Keep children away from the product, accessories and its packaging materials, it may cause suffocation.
- Do not put the product in a fire, otherwise it may cause an explosion.
- Remove the battery if the camera is not going to be used for long periods, and please fully-charged the battery before using it again.

Table Of Contents

Getting to Know Your Camera	1
Standard Accessories	1
Charging the Battery	1
Component Introduction	3
Getting Started	6
Inserting an SD Card	6
Loading Battery	7
Photo/Video Mode	8
PlayBack	13
Connecting to the Computer	16
APP	17
Downloading the APP	17
Connect Wi-Fi	17
Technical Parameters	21
Trouble Shooting	23

Getting to Know Your Camera

Standard Accessories

4K Ultra HD Camera	Battery	USB Cable
Strap	Lens Cap	User Manual

The above are all accessories, if there is any missing, please contact the seller for replacement.

Charging the Battery

Before using the camera, you must load and charge the battery

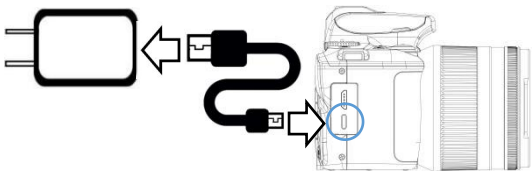

1. Please Connect the USB Cable to the charging adapter when camera is running low.
2. Connect the other side to the Camera's USB charging interface.
3. The indicator light will be red when charging; The indicator light will turn off when the charging is completed.

Note:

1. For direct charge, please use the 5V/2A charging adapter for charging.
2. When using the USB Cable to charge, if charge during working condition, the camera will automatically shut down after the charging adapter is powered off.

Component Introduction

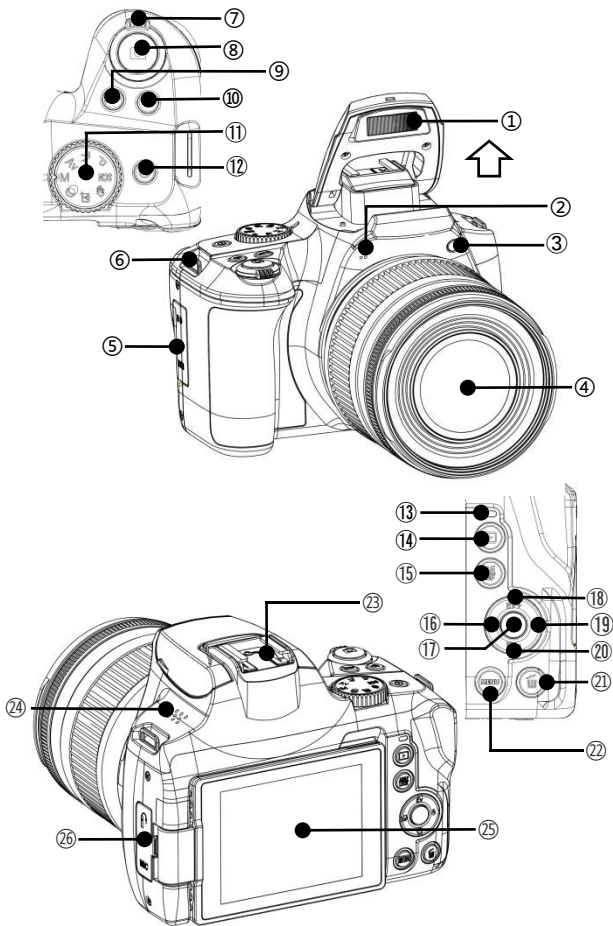

For the function description of the related parts in the above figure, please refer to the following table.

No.	Name	Function description
1	Flash	It is used to strengthen the exposure volume. It helps to make the scene brighter in a dim place. Please use it manually.
2	Built-in Microphone	Recording sound.
3	Focus lamp	In an environment with insufficient light, the camera's focusing system is illuminated by the camera, so that the focus system can accurately focus.
4	Lens	Framing.
5	HDMI&USB interface	USB : Enter the USB cable charging or connect to the computer. HDMI: External HD Cable to connect to TV.
6	Strap Mounting Hole	Install adjustable strap.
7	T/W Zoom Button	AF (normal mode): When the lens is full, the scene can be pulled into a long distance; MF (manual mode): manual focus can be performed when dialing.
8	Photo Button	Two-stage button, tap to focus and press to photo in photo mode.
9	DISP Button	Press to switch screen display mode.

10	Video Button	“START/STOP”is the recording/stop button; Stop playback when the video is playing.
11	Photo Mode Dial	Carreet AUTO (Intelligent Scene)/P (Program)/AV (Aperture Priority)/TV (Shutter Priority) /M(Manual Exposure)/SCN (scene mode)/CS (continuous shooting mode)/CA (Filter Mode) Application mode switching.
12	Power Button	Power On/Off.
13	State Light	When the green light is always on: standby. When the green light is constantly flashing: in the video. The green light flashed once: take a photo. When the green light is irregularly flashing: flash is charging. When the red light is often on: charging.
14	Playback Button	Press to enter the playback mode.
15	AE/AF Lock	Lock the current exposure value/focus distance.
16	Left Button/AF, MF Button	When entering the menu list: move left; During the standby interface: select a macro or normal mode AF (automatic Focus)/MF(manual focus).
17	OK Button	Press the confirmation function when entering the menu list.
18	Up Button/EV	When entering the menu list: move

	Exposure Button	up;During the standby interface: enter the EV exposure value adjustment.
19	Right Button/Flash Button	When entering the menu list: move right;During the standby interface: enter the flash function selection.
20	Down Button/Self Timer Button	When entering the menu list: move down;During the standby interface: enter the Self Timer selection.
21	Delete Button	Delete the file when the standby mode/playback mode.
22	Menu Button	Press to enter the Menu.
23	Hot shoe interface	Mount hot shoe products.
24	Horn	Plays back sounds.
25	IPS Panel	Screen preview and video/photo playback.
26	Shutter&MIC Interface	Shutter interface: access to the dedicated wire controller. MIC interface: access to external microphones.

Note:

1. When using the flash, please turn on and press the flash button to select the function.
2. CS (continuous shooting mode) and Video Mode can not use flash.

Getting Started

Inserting an SD Card

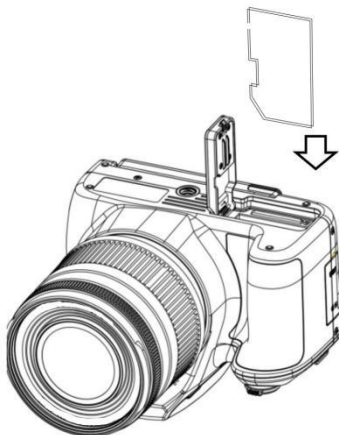

1. Open the cover.
2. Insert the memory card in the direction shown until you hear "Clicks".
3. Close the cover.

Note:

1. When using for the first time, format the SD card on this unit. The SD card needs to be U3.
2. Do not forcefully remove the SD card while working, otherwise it may cause loss of files or machine damage.

Loading Battery

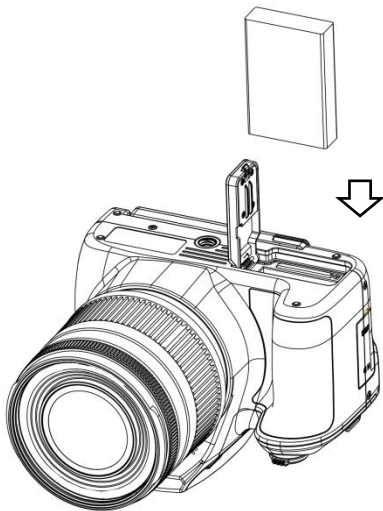

1. Open the cover..
2. inserts a lithium battery.
3. Close the cover.

Note :

1. Do not violently open the battery compartment and remove the battery.
2. The battery needs to be loaded into the battery compartment in a correct direction.

Photo/Video Mode

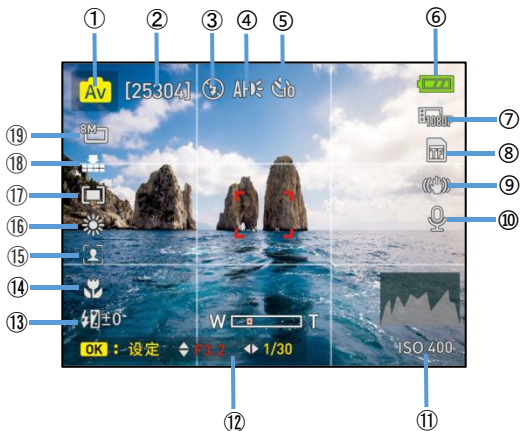

①	Photo Mode	⑪	ISO
②	Remaining number of shoots	⑫	Aperture and shutter adjustment
③	Flash state	⑬	EV exposure
④	Focus lamp	⑭	Macro mode
⑤	Self Timer	⑮	Face Detect
⑥	Battery Status	⑯	AWB
⑦	Video Resolution	⑰	Metering
⑧	Memory Card	⑱	Photo quality
⑨	Anti -shake	⑲	Photo pixel
⑩	External microphone		

1. Press the power button or open the screen to turn on the camera.

2. Set the option of the function you need by the option setting menu.
3. Press the photo button lightly to focus, and press the photo button again to take a photo.
4. Press the “Video button” to start recording.
5. Press the “Up Button/EV Exposure Button” to pause recording.
6. Press the “Video button” again to stop recording.

Photo setting menu

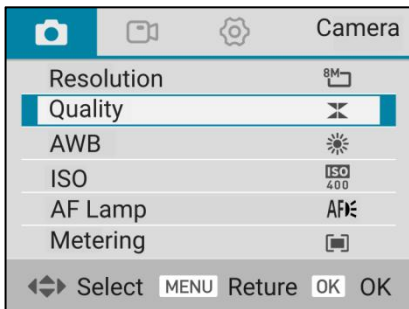

Scene	Auto/Scenery/Portrait/Sport/Night Portrait/ Night Scenery/Party/Sunset/Backlight/ High Sensitivity
Resolution	64M/32M/16M/8M
Quality	Super Fine/Fine/Normal
Metering	Multi/Center/Spot
Grid Line	On/Off
Anti-Shake	On/Off

Date Stamp	On/Off
Quick Review	Off/2 Seconds/5 Seconds
AF Lamp	Auto/Off
AE-L&AF-L	AE-L/AF-L/AE-L&AF-L
Color	Standard/Color Enhancement (Red) /Color Enhancement (Green) /Color Enhancement (Blue)/Color Enhancement(Orange)/Color Enhancement (Yellow) /Color Enhancement (Purple) /Sepia/Monochrome/Pen/Vivid

- 1.Press the power button or open the screen to turn on the camera.
- 2.Press the "Menu Button" to enter the menu.
- 3.Formulate to the place through the "Up Button/EV Exposure Button" or "Down Button/Self Timer Button" you need to function and press the "OK Button" to confirm the selection.

Video setting menu

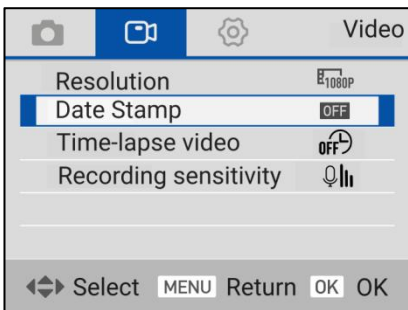

Resolution	4K24fps/2K30fps/1080P60fps/ 1080P30fps/720P60fps
Date Stamp	On/Off
Time-lapse video	Off/1 Second/3Seconds/ 5 Seconds
Recording Sensitivity	Soft/Normal/Strong

1. Press the power button or open the screen to turn on the camera.
2. Press the "Menu Button" to enter the menu.
3. Press "Right Button/Flash Button" to the video setting menu.
4. Formulate to the place through the "Up Button/EV Exposure Button" or "Down Button/Self Timer Button" you need to function and press the "OK Button" to confirm the selection.

Set Menu

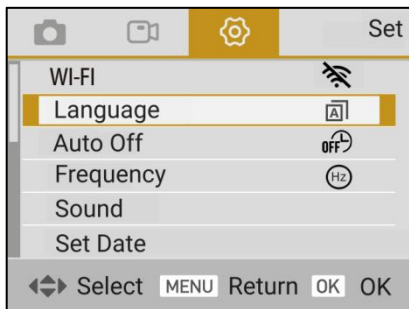

Wi-Fi	On/Off
Auto Off	None/3 Minutes/5 Minutes/10 Minutes
Language	English/German/French/Spanish/Italian/ Turkish/Russian/Portuguese/Dutch/ Simplified Chinese/Traditional Chinese/Polish
Frequency	50HZ/60HZ
Sound	Power-on sound:Off/3 sounds Shutter sound:On/Off Operating volume:Four -gear sounds
Set Date	Set Date
Format	Cancel/OK
Default	Cancel/OK
Version	Current firmware version

1. Press the power button or open the screen to turn on the camera.
2. Press the "Menu Button" to enter the menu.
3. Press "Right Button/Flash Button" to the Set menu.
4. Formulate to the place through the "Up Button/EV Exposure Button" or "Down Button/Self Timer Button" you need to function and press the "OK Button" to confirm the selection.

Play Back

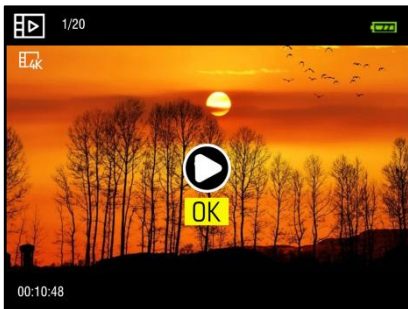

1. Press the power button or open the screen to turn on the camera.
2. Press the "Playback Button" to enter the Playback.
3. Press "Left Button/AF、MF Button" or "Right Button/Flash Button" for the previous or next item.
4. When you browse the video, press the "OK Button" to start or pause play, press the "Up Button/EV Exposure Button" or "Down Button/Self Timer Button" to adjust the sound, press the "Left Button/AF、MF Button" to rewind, press the "Right Button/Flash Button" to fast-forward, and press the "Video button" to stop playing.

5. When you browse the photo, press the "T Zoom Button", and then press the "Up Button/EV Exposure Button", "Down Button/Self Timer Button", "Left Button/AF、MF Button" or "Right Button/Flash Button" Make a partial view of the photo, and press the "OK Button" to exit the photo to enlarge.

File delete/protect

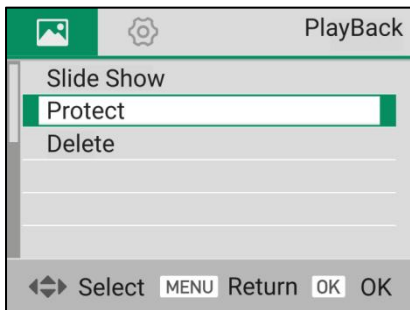

1. Press the power button or open the screen to turn on the camera.
2. Press the "Playback Button" to enter the Playback.
3. Press the "Delete Button" and "OK Button" to delete the current browsing file.
4. Press the "Menu Button" to enter the menu:
 - 4.1 Slide Show: Press the "OK Button" to confirm that the slide show function is selected, and after confirming that "Repeat" and "3S/5S/10S interval" are confirmed in the sub -menu, press "Start" to start the slide.

4.2 Protect: Press the "OK Button" to confirm the protect function, and confirm the selection of "Lock"/"Unlock"/"Lock All" or "Unlock All" function in the sub -menu.

4.3 Delete: Press the "OK Button" to confirm the delete function, and confirm that "Delete Current" or "Delete All " in the sub -menu.

Note: 1.Press the "Delete button" at the standby interface to directly delete the current file.
2.The locked file cannot be deleted and must be unlocked manually.

Connecting to the Computer

This function allows you to use your camera as a MSDC disk or PC Camera

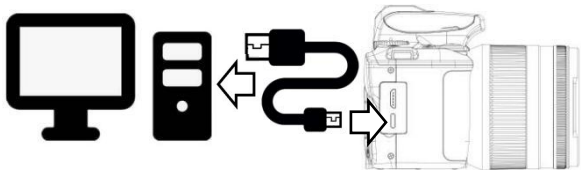

MSDC Mode

1. Press the power button or open the screen to turn on the camera.
2. Connect the camera and computer with the cable.
3. The screen will display two options: "MSDC" and "PC Camera".
4. Select the "MSDC" by "OK Button" .

PC Camera

1. Press the power button or open the screen to turn on the camera.
2. Connect the camera and computer with the cable.
3. The screen will display two options: "MSDC" and "PC Camera".
4. Select the "PC Camera" by "Down Button/Self Timer Button" and "OK Button".

Note: When use the camera as a PC Camera, the camera is not able to record video.

APP

Downloading the APP

For Android: Search “D Video”
in Play store and download.

For IOS: Search “D Video”
in App store and download.

Or scan the QR Code to
download the APP.





Connect Wi-Fi

1. Press the power button or open the screen to turn on the camera.
2. Press the “Menu Button” to enter the menu.
3. Press “Right Button/Flash Button” to the Set menu.
4. Press the “Up Button/EV Exposure Button” or “Down Button/Self Timer Button and the “OK Button” confirm the selection and turn on the WiFi function.
4. Open your phone and open the Wi-Fi search the name with G700xxxxxx, Enter the password : 12345678
5. Enter the APP, touch “Connect Camera”.

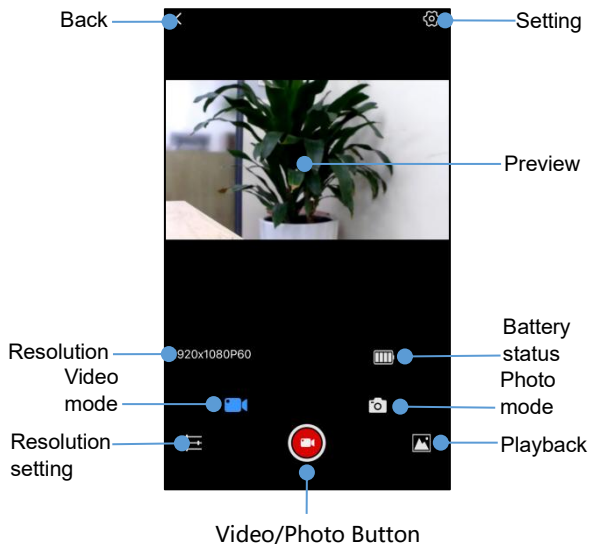

Note: The Wi-Fi function is a point-to-point wireless connection with a limited distance. The maximum distance is about 7 meters. Please use this function within the effective distance.



APP Video Mode

1. Press the  on the App user interface to enter the Video mode.
2. Touch the  icon , "REC" will be displayed at the top Right of the interface and flashes on the live preview., Start recording.
3. Touch the  icon again, Stop recording.

APP Photo Mode

1. Press the  on the App user interface to enter the Photo mode.
2. Press the  icon in live preview mode, the app will sound "click".
3. Finished.





APP Setting

This setting function allows you to customize the parameters of the camera, such as the resolution, audiorecording, and date







Press the  on the App user interface to enter the Setting menu.

Video Setting	Resolution	Select resolution
Photo Setting	Photo Size	Select resolution
	Exposure	+3.0/+2.0/+1.0/0.0/ -1.0/-2.0/-3.0
	Wi-Fi setting	ID/Password
	Format	YES/NO
	Default Setting	Cancel/Confirm
	Surplus Space	View the storage of camera
Firmware Version	Camera Version	

A.Photo



- 1.Press the  on the App user interface to enter the Play Back mode.
- 2.In the main interface of the playback, select “**Photo**” to enter the thumbnail preview interface.
- 3.Select any one of the document thumbnail to play or  delete  download the video to local.
- 4.After you press  to download the photo to the local album, you can share it to the social media by clicking  .

B.Video

- 1.Press the  on the App user interface to enter the Play Back mode.
- 2.In the main interface of the playback, select “**Video**” to enter the thumbnail preview interface.
- 3.Select any one of the document thumbnail to play or download the video to local.
- 4.By selecting the  on the upper right corner to single-select/multi-select video, you can delete  or download  it to the local album.
- 5.After you press  to download the photo to the local album, you can share it to the social media by clicking  .

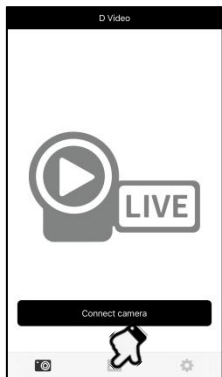
C. Album



1. Press  on the main interface to enter the local album.
2. In the main interface of the playback, select “Video” or “Photo” to enter the thumbnail preview interface.
3. Select any one of the document thumbnail to play , delete  or share it to the social media by clicking 

Technical Parameters

Sensor	8.0MP CMOS
Aperture	F: 2.8 ~ 3.1
Lens	f=4.9 ~ 59mm
Focus Range	Wide: 0.1m~INF Tele: 1.5m~INF
Lens Type	Optical zoom lens
Zoom	12X Optical Zoom 30X Digital Zoom

External Storage	Support SD/SDHC Card(U3), Maximum 256GB
Screen	3.0-inch IPS Screen
Video Resolution	4K :2880*2160 24fps 2K :2560*1440 30fps FHD:1920*1080 60fps/1920*1080 30fps HD:1280*720 60fps
Photo Resolution	64M(9200*6900)/32M(6480*4860) 16M(4608*3456)/8M(3264*2448)
File Format	Video:MP4 Photo:JPEG
ISO	Auto/100/200/400/800/1600/3200
Wi-Fi	Support
Flash	Yes
Hot Shoe	Support external mic/LED light
I/O Interface	USB/HDMI/Shutter/MIC
Speaker	Built-in
Microphone	Built-in
Battery	NP120 Li-ion battery
Working Temperature	0 ~ 40 °C

Trouble Shooting

Trouble	Possible reason	Solution
Cannot power on	Battery is not inserted correctly/dead	Insert battery correctly/Charge
Unclear Focus	Out of focus range / lens dirty	Shooting in focus able range/Clean the lens
Unable to use memory card/unable to record	Card damage / SD card does not meet requirement	Replace the SD card / Format the SD Card / Use the U3 Card
Fail to use it as a PC Cam	USB Cable is loose / Computer system version is not compatible	Replace the USB interface / Select a compatible system

This equipment has been tested and found to comply with the limits for a Class B digital device, pursuant to part 15 of the FCC Rules. These limits are designed to provide reasonable protection against harmful interference in a residential installation. This equipment generates, uses and can radiate radio frequency energy and, if not installed and used in accordance with the instructions, may cause harmful interference to radio communications. However, there is no guarantee that interference will not occur in a particular installation. If this equipment does cause harmful interference to radio or television reception, which can be determined by turning the equipment off and on, the user is encouraged to try to correct the interference by one or more of the following measures:

- Reorient or relocate the receiving antenna.
- Increase the separation between the equipment and receiver.
- Connect the equipment into an outlet on a circuit different from that to which the receiver is connected.
 - Consult the dealer or an experienced radio/TV technician for help.

Caution: Any changes or modifications to this device not explicitly approved by manufacturer could void your authority to operate the equipment.

This device complies with part 15 of the FCC Rules. Operation is subject to the following two conditions:

- (1) This device may not cause harmful interference, and
- (2) this device must accept any interference received, including interference that may cause undesired operation.

This equipment complies with FCC RF radiation exposure limits set forth for an uncontrolled environment. This device and its antenna must not be located or operating in conjunction with any other antenna or transmitter.



2ALYUG700