

Overview

Thank you for purchasing this portable digital video camera, this camera features video recording at 4K. With resolution of 3840*2160, it adopted 1/3-inch image sensor, the video file storage usage is small while it has high image quality! You can connect your camera via Wi-Fi using your smart Phone remotely, to view the camera live screen and use your phone to record or shooting.

Safety Instructions

- Do not drop, impact or puncture the camera
- Do not expose the camera to high/low temperature, excessive dust, humidity or strong vibration, otherwise the product may be damaged.
- Do not use corrosive chemicals or solvents to clean the product.
- Do not disassemble this camera or attempt to repair or modify it in any manner.

Cautions

- Keep children away from the product, accessories and its packaging materials, it may cause suffocation.
- Do not put the product in a fire, otherwise it may cause an explosion.
- Remove the battery if the camera is not going to be used for long periods, and please fully-charged the battery before using it again.

Table Of Contents

Getting to Know Your Camera	1
Standard Accessories	1
Charging the Battery	1
Component Introduction	3
Getting Started	7
Inserting an SD Card	7
Loading Battery	8
Recording Mode	9
Photo Mode	12
Set Mode	18
Playback	20
Connecting to TV	23
Connecting to the Computer	24
APP Using	25
APP Downloading	25
APP Connecting	25
APP Functions	27
Technical Parameters.....	30
Troubleshooting.....	32

Getting to Know Your Camera

Standard Accessories

4K Ultra HD Camera

Infrared remote control

Battery

HDMI Cable

Charger

User Manual

USB Cable

DV Pouch

The above are all accessories, if there is any missing, please contact the seller for replacement.

Charging the Battery

Before using the camera, you must load and charge the battery

Charging with the Charger

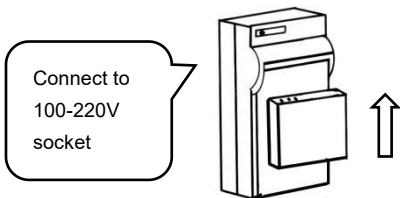

Note: Insert the battery into the charger to charge it, the indicator light will be red when charging; The indicator light will turn green when the charging is completed.

Charging with USB Cable (Direct Charge)

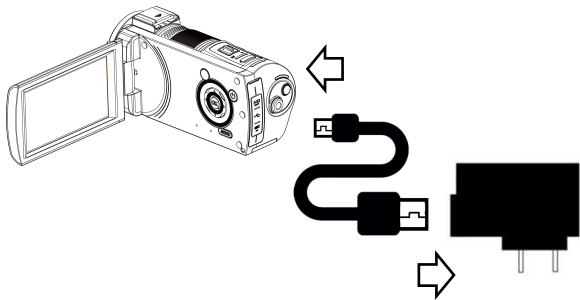

1. Please Connect the USB Cable to the charging adapter when camera is running low.
2. Connect the other side to the Camera's USB charging interface.
3. The indicator light will be red when charging; The indicator light will turn green when the charging is completed.

Note:

1. When using the charger, please install the battery in the charger slot correctly.
2. For direct charge, please use the 5V/2A-2.5A charging adapter for charging.
3. When using the USB Cable to charge, if charge during working condition, the camera will automatically shut down after the charging adapter is powered off.

Component Introduction

A

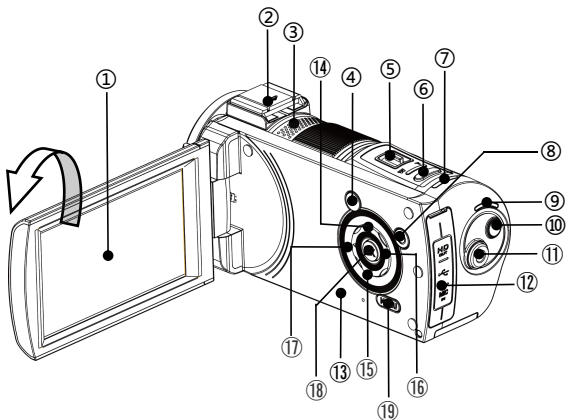

For the function description of the related parts in the above figure, please refer to the following table.

No.	Name	Function description
①	IPS Touch Panel	Screen preview and video/photo playback.
②	Hot shoe interface	Mount hot shoe products.
③	Horn	Plays back sounds.
④	DISP Button	Press to switch screen display Mode.

⑤	T/W Zoom Button	In video/Photo Mode, pull left/right to zoom in/out; In Playback Mode, pull to switch photos/videos; In Menu, pull to menu selection. In Video Playback, pull to adjust the volume.
⑥	Photo Button	Two-stage button, tap to focus and press to photo in photo mode.
⑦	Power indicator	Always on after power on.
⑧	Power Button	Power On/Off.
⑨	State Light	Display of mode status.
⑩	Mode Button	Press to enter the mode menu while in photo / video / playback mode.
⑪	Video Button	1.Recording/stop video. 2.Stop playback when the video is Playing.
⑫	I/O Interface	10PIN USB interface: Access the USB Cable to charge; HDMI: External HD Cable to connect to TV; MIC:Access to an external microphone.
⑬	Built-in microphone	Recording sound.
⑭	Up Button/IR Night Vision Switch	When entering the menu, press to move the cursor upward; when in

		the photo / recording mode, press to turn on / off the IR Light..
⑮	Down Button/"Delete" Shortcut	When entering the menu, press and move the cursor down; Press to delete recent videos or photos.
⑯	Right Button/Increased exposure	When entering the menu, press and move the cursor to the right; In photo / video mode, press exposure to increase the exposure value.
⑰	Left Button/Reduce exposure	When entering the menu, press and move the cursor to the left; In photo / video mode, press exposure to decrease the exposure value.
⑱	Confirm Button	After entering the menu to select the function option, press to confirm the selection.
⑲	Menu Button	Press to enter the Menu.

B

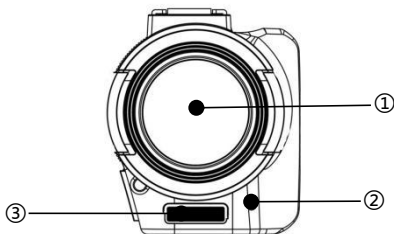

For the function description of the related parts in the above figure, please refer to the following table.

No.	Name	Function description
①	Lens	Framing
②	Infrared remote-control receiver	Receiving remote command
③	IR Light	Lighting assist

C

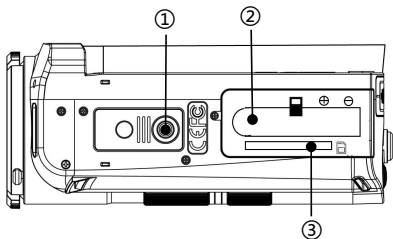

For the function description of the related parts in the above figure, please refer to the following table.

No.	Name	Function description
①	1/4 Tripod Socket	Tripod installation.
②	Battery Compartment	Load NP-40B Battery.
③	SD slot	Open and insert the SD Card.

Getting Started

Inserting an SD Card

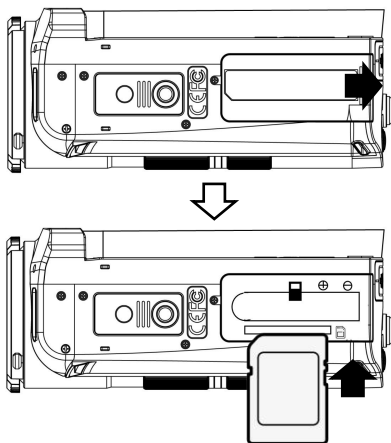

1. Open the Battery cover.
 2. Insert the memory card in the direction shown until you hear **“Clicks”**.
 3. Close the Battery cover.
- ※ **Open the Battery cover and press the memory card.**

Note:

1. It is strongly recommended to use U3, which supports up to 256G high-speed memory card.
2. Do not forcefully remove the SD card while working, otherwise it may cause loss of files or machine damage.

Loading Battery

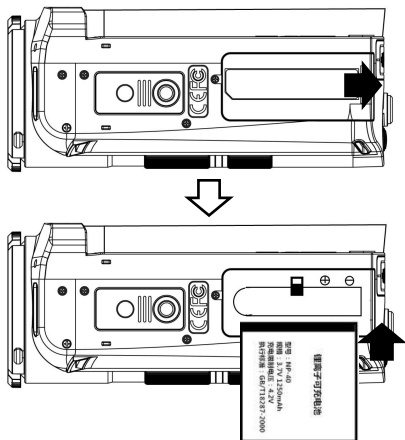

1. Open the Battery cover.
2. inserts a lithium battery.
3. Close the battery cover.

Note:

1. Do not violently open the battery cover and remove the battery.
2. The battery needs to be loaded into the battery compartment in a correct direction.

Recording Mode

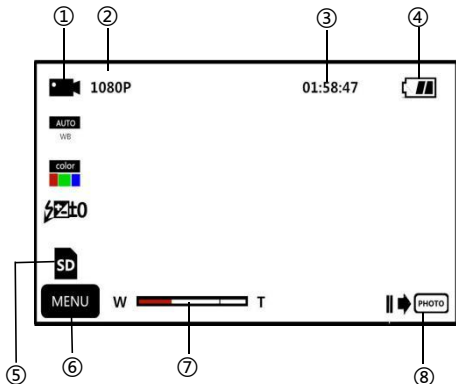



①	Recording mode	⑤	Memory Card
②	Resolution	⑥	Menu
③	Remaining video recording time	⑦	Zoom
④	Battery Status	⑧	Pause recording

1. Press the **"Power Button"** or open the screen to turn on the camera, enter the video mode.
2. Set the option of the function you need by the option setting menu.
3. Press the Rec button to start shooting.
4. Press the Rec button again to stop shooting.
5. Press the photo button to pause when recording and press it again to continue.

Video setting menu

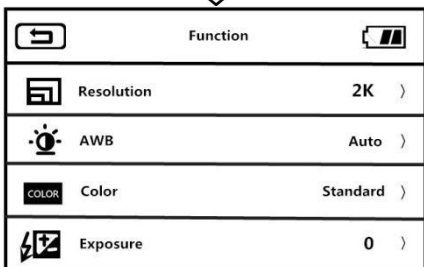
Enter the menu by button or touch, you can set the resolution, white balance, exposure and other function parameters to get better video results



1. Enter the video mode .
2. Press the “**Menu Button**” or touch the  icon on the screen to enter the menu.
3. Touch the  on the screen to enter the menu.

Name	Function Description
------	----------------------

Resolution	4K30fps/2K30fps/FHD30fps/HD30fps/ VGA30fps/FHD60fps/HD120fps
AWB	Auto/Daylight/Cloudy/Fluorescent/ Tungsten
Color	Standard/Brown/Black、 White/ Realistic Color
Exposure	+3 ~ -3
Date Stamp	On/Off
Metering	Multi/Center/Spor

Note: Use FHD60FPS and HD120FPS non-zoom.

4. By switching the “**T/W Zoom Button**” “**Up Button**”、“**Down Button**” or swipe screen to select the setting option freely.

5. By touching or pressing the “**Photo Button**”、“**Confirm Button**” to select the option, for example: Resolution, enter the option menu, select the resolution you need, touch



to return to the main menu, touch



to return to the standby main interface.

Time-lapse Video





This feature allows you to compress a few minutes, hours or even days of video playback in a short period of time

1. Enter the video mode.

2. Press the **“Menu Button”** or touch the  icon on the screen to enter the menu.

3. Touch  to enter the option menu: off/1s/3s/5s.

4. By touching or pressing the **“Photo Button”** to select the

option, touch  to return to the main menu, touch  to return to the standby main interface.

Note: 1s.3s.5s is the interval time of each frame.

Photo Mode

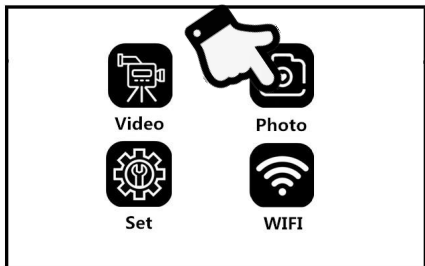

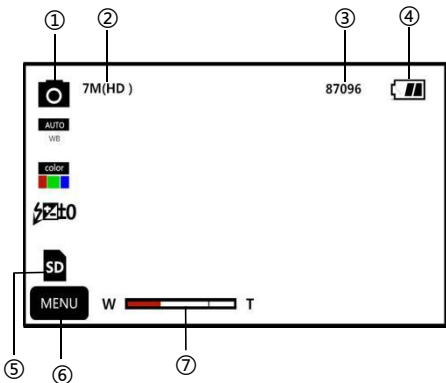

①	Photo mode	⑤	Memory Card
②	Resolution	⑥	Menu
③	Remaining number of shoots	⑦	Zoom
④	Battery Status		

1. Press the **"Photo Button"** or open the screen to turn on the camera, Press **"Mode Button"** to enter the mode menu, and



Touch  to enter the main interface of the photo mode.

2. Set the option of the function you need by the option setting menu.
3. Press the **"Photo Button"**, take a picture .

Photo setting menu

Enter the menu by button or touch. You can set the resolution, white balance, exposure and other function parameters to get better photo results in the menu.

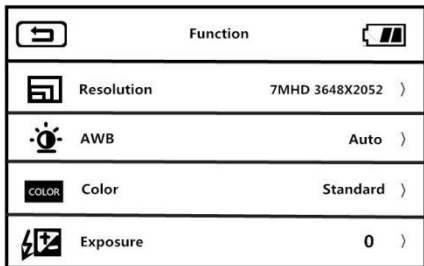
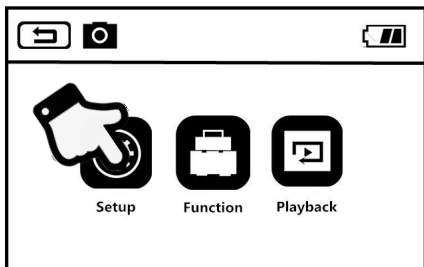



1. Enter the Photo mode .
2. Press the **"Menu Button"** or touch the **MENU** on the screen to enter the menu.

3. Touch the  on the screen to enter the set menu.

Name	Function Description
Resolution	30M/24M/20M/16M/12M/10M/7MHD 5M/2MHD/VGA
AWB	Auto/Daylight/Cloudy/Fluorescent/ Tungsten
Color	Standard/Brown/Black、 White/ Realistic Color
Exposure	+3 ~ -3
Metering	Multi/Center/Spot
Sharpness	Soft/Normal/Sharp
ISO	Auto/100/200/400/800/1600

4. By switching the “**T/W Zoom Button**” 、 “**Up Button**” 、 “**Down Button**” or swipe screen to select the setting option freely.

5. By touching or pressing the “**Photo Button**” 、 “**Confirm Button**” to select the option, for example: Resolution, enter the option menu, select the resolution you need,

press  to return to the main menu, press  to return to the standby main interface.

Function

By using various features in this option menu allows you to take pictures easier and faster

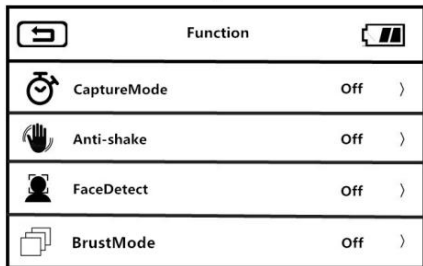
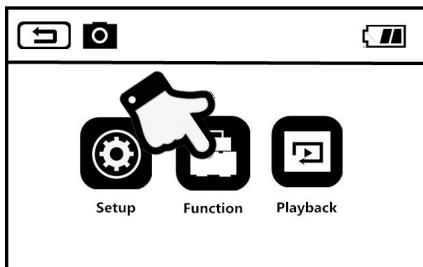

Name	Function Description
Capture Mode	By selecting: Off, 2s, 5s, 10s to selfie.
Anti-Shake	Turn on this function can effectively reduce the picture jitter cause by strong vibration.

Face Detect	When this function is turned on, the face will be in priority focus when the camera detects a human face
Burst Mode	Take three consecutive photos
Date Stamp	Turn on this function to add a date watermark in the lower right corner of the photo

1. Enter the photo mode, press “**Menu button**” or touch  to enter the main menu.

2. Touch  to enter the option menu.

3. By switching the “**T/W zoom Button**” 、 “**Up Button**” 、 “**Down Button**” or swipe screen to select the setting option freely.

4. By touching or pressing the “**Photo Button**” to select the option, for example: Capture Mode, enter the option menu,





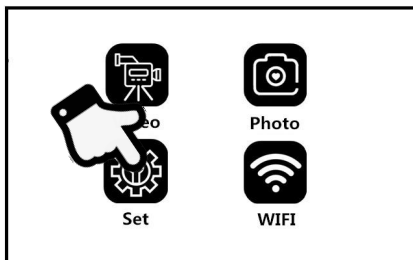

select the option you need, touch  to return to the

main menu, touch  to return to the standby main interface.

Set Mode

Through this setting menu, you can customize the function parameters such as language, date and frequency.



	Set	
	Language	English >
	Sound	On >
	Far Mode	Off >
	SetData	SetData >

Name	Function Description
Language	13 Languages.
Sound	Turn On/Off the camera button sound.
Far Mode	On/Off
Set Date	Customize the date and time of the photo or video.

Frequency	Normally, 60Hz is suitable for US or other countries. While 50 Hz is suitable for European countries and Japan and so on.
Auto Off	Off/3mins/5mins/10mins.
Format	Yes/No.
Default	Yes/No.

1. Press the "**Power Button**" or open the screen to turn on the camera, Press "**Mode Button**" to enter the mode menu, and



Touch  to enter the main interface of the SET mode.

2. By switching the "**T/W Zoom Button**"、"**Up Button**"、"**Down Button**" or swipe screen to select the setting option freely.
3. By touching or pressing the "**Photo Button**" to select the option.

4. press  or  to return to the main menu.

PlayBack

This function allows you to play recorded video or photo in the camera

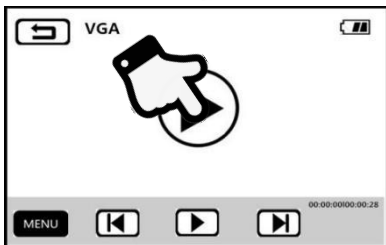
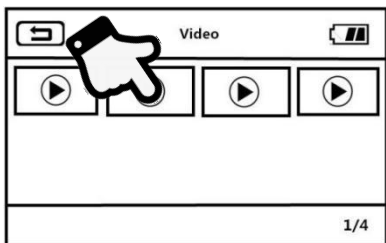
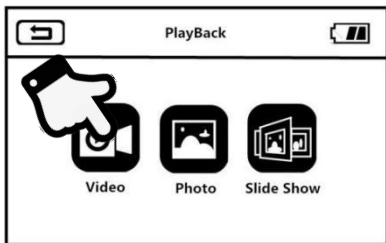



Video

1. Press the **"Menu Button"** or touch  to enter the menu interface in the photo or recording mode.

2. Touch  to enter the playback function menu.

3. Touch  the video option to enter the 12 palace video playback interface

4. Select any one of the video thumbnail to enter the preview screen.

5. Switch to the previous or next by touching  or .

6. By Touching  button or **"Photo Button"** to start playback.

7. During the playback, press **"T/W Zoom Button"** to adjust the sound, press the **"Photo Button"** to pause playback, press **"Record button"** to stop playing.

8. By Touching  or pressing the **"Menu Button"**, you can delete the current file, delete all files, lock or unlock current file or all files.

Photo



1. Press the **"Menu Button"** or touch  to enter the menu interface in the photo or recording mode.

2. Touch  to enter the playback function menu.

3. Touch  the video option to enter the 12 palace photo

playback interface

4. Select any one of the Photo thumbnail to Browse photos.

5. Switch to the previous or next by touching  or  .

6. By touching  or pressing the "**Menu Button**", you can delete the current file, delete all files, lock or unlock current file or all files.

Slide Show

1. Press the "**Menu Button**" or touch  to enter the menu interface in the photo or recording mode.

2. Touch the  to enter the Slide Show interface

3. By touching the  play button or "**Photo Button**" to start play

4. By touching  or pressing the "**Menu Button**", you can select 3S, 5S, 10S play time

Note: 3S, 5S, 10S options are the interval time of each picture.

Connecting to TV

When connect the HDMI to your camera's HDMI output and your TV, the image on your screen can also be displayed on your TV screen.

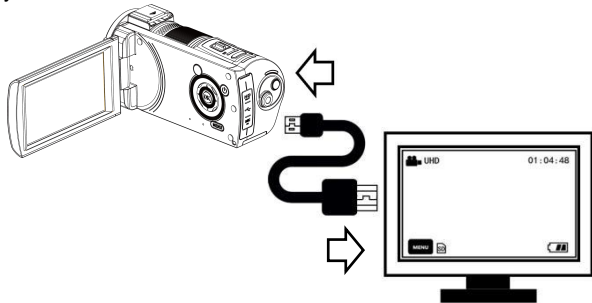

1. Press the power button or open the screen to turn on the camera and enter the standby state.
2. Take out the HDM cable and connect the camera with the HDMI connector of the TV.
3. Turn the TV to the HDMI channel, the preview screen will appears on the TV.

Connecting to the Computer

This function allows you to use your camera as a MSDC disk or PC Camera

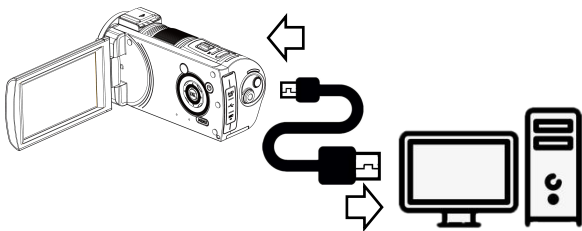

MSDC Mode

1. Power on the camera and enter the standby mode.
2. Connect the camera and computer with the cable.
3. The screen will display two options: "MSDC" and "PC Camera".
4. Select the "**MSDC**" by "**T/W Zoom Button**".
5. Press "**Photo Button**" to confirm.

PC Camera Mode

1. Power on the camera and enter the standby mode.
2. Connect the camera and computer with the cable.
3. The screen will display two options: "MSDC" and "PC Camera".
4. Select the "**PC Camera**" by "**T/W Zoom Button**".
5. Press "**Photo Button**" to confirm.

APP Using

APP Downloading

For Android: Search “**D Video**”
in Google Play and download,
For IOS: Search “**D Video**”
in App store and download.
Or scan the QR Code to
download the APP.



APP Connecting

1. Press the power button or open the screen to turn on the camera, Press "**Mode Button**" to enter the mode menu, and



Touch  to enter the main interface of the WiFi mode.

2. Open your phone and open the Wi-Fi search the name with **HDVxxxxxx**, Enter the password : **12345678** .



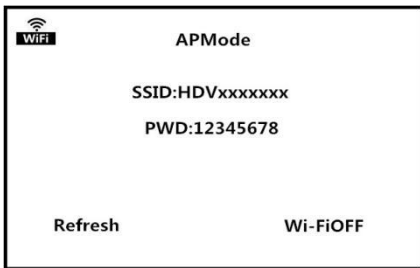

3. Enter the APP, touch " **Camera**".



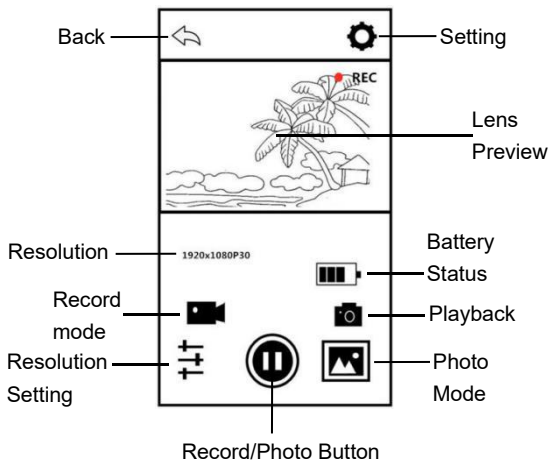

Note: The Wi-Fi function is a point-to-point wireless connection with a limited distance. The maximum distance is about 10 meters. Please use this function within the effective distance.





App Functions

You can remote control the camera to record, photo taking, playback and parameter setting on the APP

APP Video Mode

1. Touch the  on the App user interface to enter the Video mode.
2. Touch the  icon , "REC" will be displayed at the top Right of the interface and flashes on the live preview., Start recording.
3. Touch the  icon again, Stop recording.

APP Photo Mode

- 1.Touch the  on the App user interface to enter the Photo mode.
- 2.Press the  icon in live preview mode,the app will sound "**click**".
- 3.Finished.

APP Setting

This setting function allows you to customize the parameters of the camera, such as the resolution, audio recording, and date





Press the  on the App user interface to enter the Setting menu.

Video Setting	Resolution	Any selection of desired resolution
	Cyclic Record	Off/3Mins/5Mins/10Mins
Photo Setting	Photo Size	Any selection of desired resolution
	Exposure compensation	+3.0/+2.0/+1.0/0.0/-1.0/-2.0/-3.0
Other Setting	Motion detection	Auto/Day/Cloudy/Fluorecent/Tungsten light
	Wi-Fi setting	ID/Password
	Format	YES/NO
	Surplus Space	View the storage of camera
	Firmware Version	Camera Version





APP Play Back

Through this function, the recorded video and photos can be played online on the APP and downloaded to the phone.

A.Photo

- 1.Press the  on the App user interface to enter the Play Back mode.
- 2.In the main interface of the playback, select “**Photo**” to enter the thumbnail preview interface.
- 3.Select anyone of the document thumbnail to play.
- 4.Touch  in the upper right corner to select any file you want to  delete or  download to the local album.

B. Video

- 1.Press the  on the App user interface to enter the Play Back mode.
- 2.In the main interface of the playback, select “**Video**” to enter the thumbnail preview interface.
- 3.Select anyone of the document thumbnail to play.
- 4..Touch  in the upper right corner to select any file you want to  delete or  download to the local album.

C. Album



1. Press  on the main interface to enter the local album.
2. In the main interface of the playback, select **"Video"** or **"Photo"** to enter the thumbnail preview interface.

3. Select any one of the document thumbnail to play , 

delete or



share it to the social media by touching.

Technical Parameters

Sensor	13.0MP CMOS
Aperture	F: 2.2
Lens	F=4.88mm
Focus Range	1m ~ infinity
Lens Type	Digital zoom lens

Zoom	30X
External Storage	Support SD Card(U3), Maximum 256GB
Screen	3.5-inch IPS Touch Screen
Video Resolution	Standard: 4K :3840*2160 30fps 2K :2560*1440 30fps FHD :1920*1080 30fps HD :1280*720 30fps VGA :640*480 30fps Sports: FHD :1920*1080 60fps HD :1280*720 120fps
Photo Resolution	30M(6400*4800)/24M(5600*4200)/ 20M(5200*3900)/16M(4608*3456)/ 12M(4000*3000)/10M(3648*2736)/ 7MHD(3648*2052)/5M(2592*1944)/2M HD(1920*1080)/VGA(640*480)
File format	Video:MP4 Photo:JPEG
ISO	Auto/100/200/400/800/1600
Wi-Fi	Support
IR Night Vision	Yes
Hot Shoe	Support external Microphone/LED light
USB Port	USB2.0: DC IN
Lens Caliber	M=37mm
Speaker	Built-in
Microphone	Built-in
Battery	NP-40 Li-ion battery
Working Temperature	0 ~ 40 °C

Troubleshooting

Trouble	Possible reason	Solution
Cannot power on	Battery is not inserted correctly/dead	Insert battery correctly/Charge
Unclear Focus	Out of focus range / lens dirty	Shooting in focus able range/Clean the lens
Unable to use memory card/unable to record	Card damage / SD card does not meet requirement	Replace the SD card / Format the SD Card / Use the U1 Card
Fail to use it as a PC Cam	USB Cable is loose / Computer system version is not compatible	Replace the USB interface / Select a compatible system

FCC Statement

This equipment has been tested and found to comply with the limits for a Class B digital device, pursuant to part 15 of the FCC Rules. These limits are designed to provide reasonable protection against harmful interference in a residential installation. This equipment generates, uses and can radiate radio frequency energy and, if not installed and used in accordance with the instructions, may cause harmful interference to radio communications. However, there is no guarantee that interference will not occur in a particular installation. If this equipment does cause harmful interference to radio or television reception, which can be determined by turning the equipment off and on, the user is encouraged to try to correct the interference by one or more of the following measures:

- Reorient or relocate the receiving antenna.
- Increase the separation between the equipment and receiver.
- Connect the equipment into an outlet on a circuit different from that to which the receiver is connected.
- Consult the dealer or an experienced radio/TV technician for help.

Caution: Any changes or modifications to this device not explicitly approved by manufacturer could void your authority to operate this equipment.

This device complies with part 15 of the FCC Rules. Operation is subject to the following two conditions: (1) This device may not cause harmful interference, and (2) this device must accept any interference received, including interference that may cause undesired operation.

This equipment complies with FCC RF radiation exposure limits set forth for an uncontrolled environment. This device and its antenna must not be located or operating in conjunction with any other antenna or transmitter.



2ALYUHDR-AX10